

GRUPPOLUBE



PORTAPOSATE 800

ACCESSORI PER CASSETTO 2023

COME ORGANIZZARE E TENERE IN ORDINE I CASSETTI DELLA CUCINA

Riorganizzare i cassetti della cucina è un'operazione periodica, che ti permette di pulire a fondo gli spazi e ordinare i diversi utensili, per avere tutto a portata di mano (e di occhio!).

Quante volte apri i cassetti della cucina e non trovi quello che cerchi?

Probabilmente è davvero ora di fare un pò d'ordine!

Prima di tutto, fare decluttering può servire per eliminare eventuali utensili che non usiamo mai, ma anche capire se sono nel posto giusto ed eventualmente decidere come cambiarne la disposizione nei diversi cassetti.

Il passo successivo è suddividere i cassetti per ottimizzare lo spazio e tenere tutto in ordine: l'ideale è utilizzare divisori che ti permettono la massima flessibilità, come il nuovo accessorio 800.

PIÙ SPAZIO

La possibilità di utilizzare ogni millimetro utile, ti farà probabilmente scoprire di avere più spazio di quanto credessi: e così potrai avere davvero tutto a portata di mano, rendendo l'esperienza in cucina ancora più piacevole!

HOW TO ORGANIZE AND KEEP KITCHEN DRAWERS TIDY

Reorganizing the kitchen drawers is a periodic operation, which allows you to thoroughly clean the spaces and order the different ones utensils, to have everything at hand (and in sight!).

How many times do you open the kitchen drawers and can't find what you are looking for?

It's probably really time to tidy up a bit!





First of all, decluttering can be used to eliminate any tools that we never use, but also to understand if they are in the right place and eventually decide how to change the arrangement in the different drawers.

The next step is to divide the drawers to optimize space and keep everything in order: the ideal is to use dividers that allow you maximum flexibility, like the new 800 accessory.

MORE SPACE

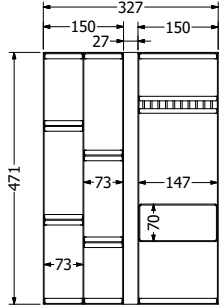
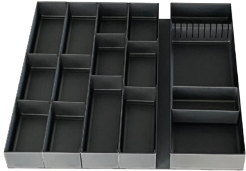
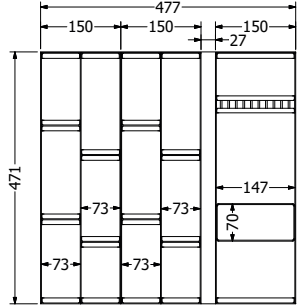
The possibility of using every useful millimeter will probably make you discover that you have more space than you thought: and so you can really have everything at your fingertips, making the cooking experience even more enjoyable!

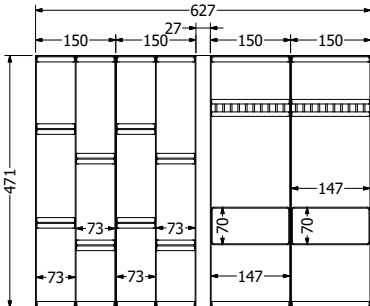
PORTA POSATE IN ALLUMINIO ANODIZZATO ANTRACITE CON TAPPETINO GRIGIO ANTRACITE
CUTLERY TRAY IN ANTHRACITE ANODIZED ALUMINUM WITH ANTHRACITE GRAY MAT

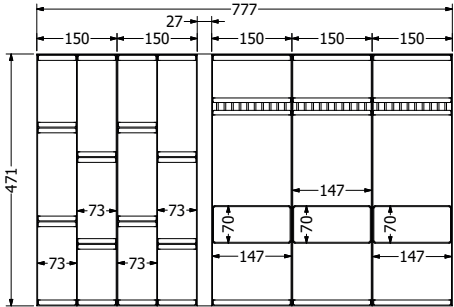
<p>Kit per cassetto antracite Drawer kit anthracite</p>   <p style="text-align: right;">45</p>	<p>CODICE / CODE No.</p> <p style="text-align: center;">08700192A</p>	
<p>Kit per cassetto antracite Drawer kit anthracite</p>   <p style="text-align: right;">60</p>	<p>CODICE / CODE No.</p> <p style="text-align: center;">08700194A</p>	
<p>Kit per cassetto antracite Drawer kit anthracite</p>   <p style="text-align: right;">75</p>	<p>CODICE / CODE No.</p> <p style="text-align: center;">08700196A</p>	
<p>Kit per cassetto antracite Drawer kit anthracite</p>   <p style="text-align: right;">90</p>	<p>CODICE / CODE No.</p> <p style="text-align: center;">08700197A</p>	

PORTA POSATE IN ALLUMINIO ANODIZZATO ANTRACITE CON TAPPETINO GRIGIO ANTRACITE
CUTLERY TRAY IN ANTHRACITE ANODIZED ALUMINUM WITH ANTHRACITE GRAY MAT

**Kit per cassetto
antracite**

Drawer kit
anthracite

CODICE / CODE No.

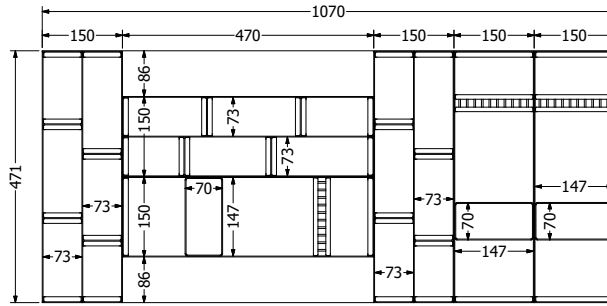

120

08700198A

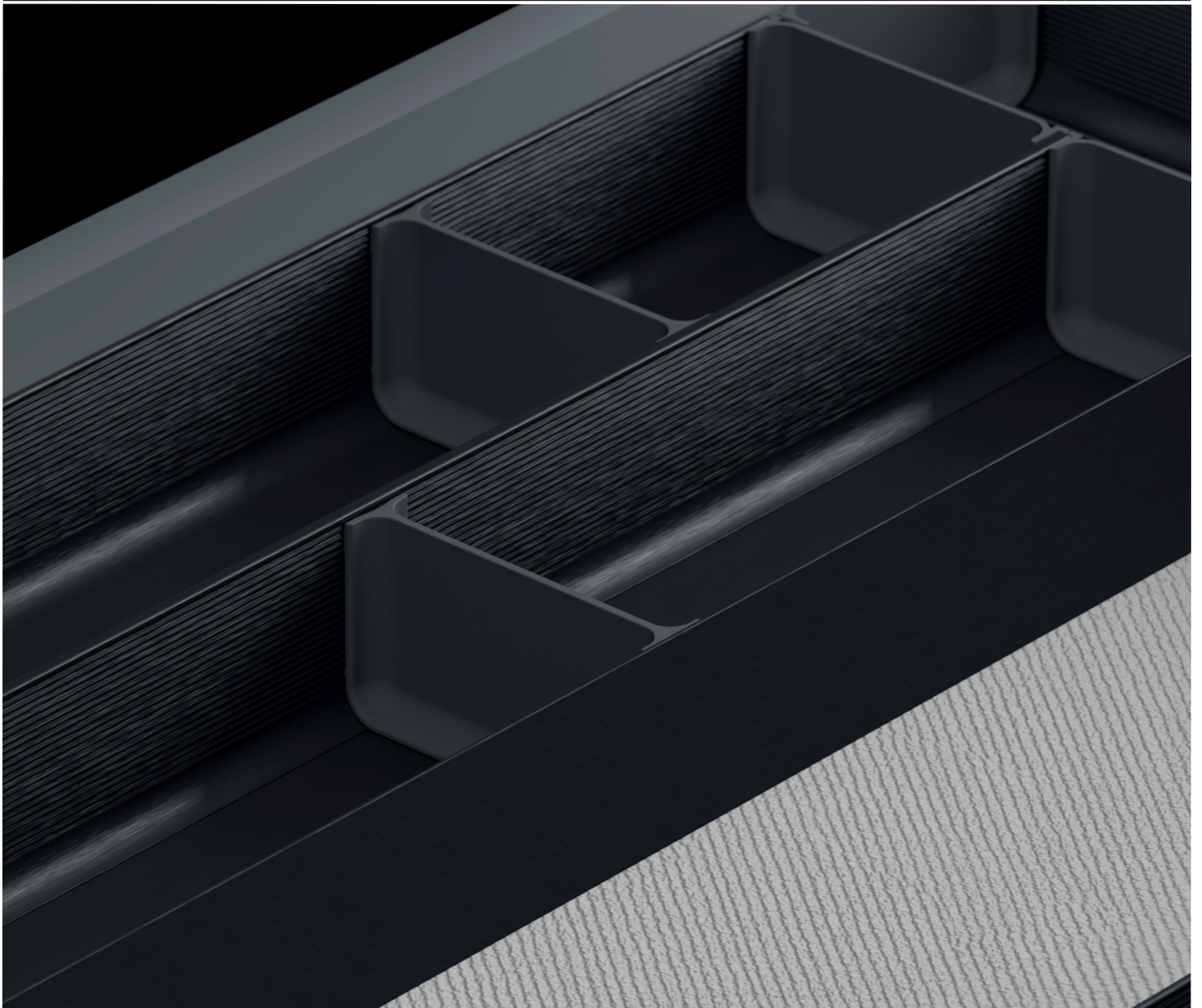

PORTA POSATE IN ALLUMINIO ANODIZZATO ANTRACITE, CON TAPPETINO GRIGIO ANTRACITE
CUTLERY TRAY IN ANTHRACITE ANODIZED ALUMINIUM, WITH ANTHRACITE GRAY MAT

SPECIFICHE E CARATTERISTICHE — SPECIFICATIONS AND FEATURES

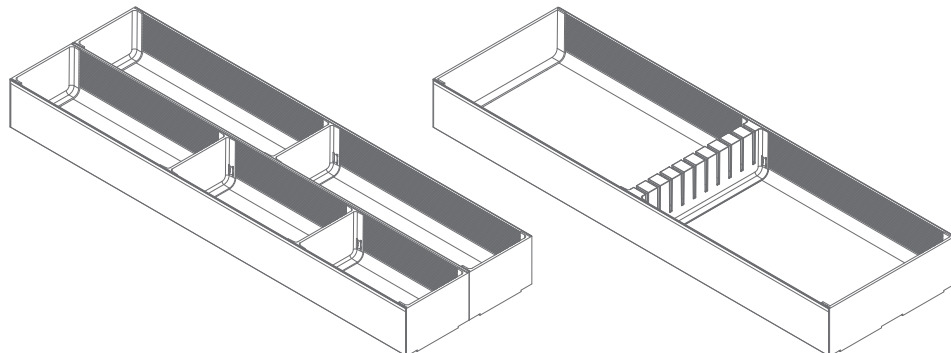

DIMENSIONI — DIMENSIONS

PROFILO PORTAPOSATE DOPPIO IN ALLUMINIO
DOUBLE DRAWER DIVIDER IN ALUMINIUM

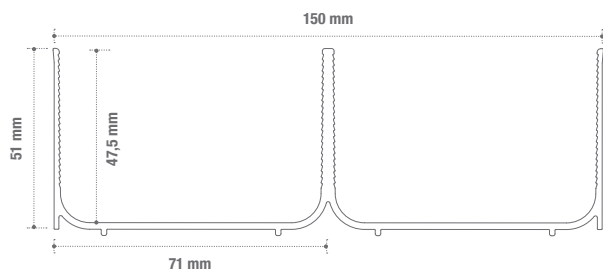

PROFILO PORTAPOSATE SINGOLO IN ALLUMINIO
SINGLE DRAWER DIVIDER IN ALUMINIUM

